

# Gummi fender profiler

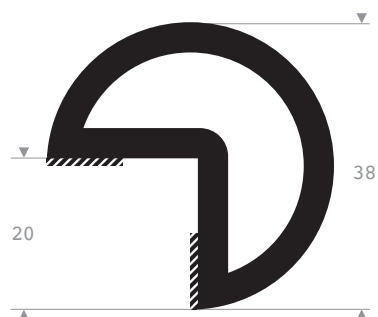

215.00.801  
EPDM 70° Shore m/tape  
rull lengde 20 meter

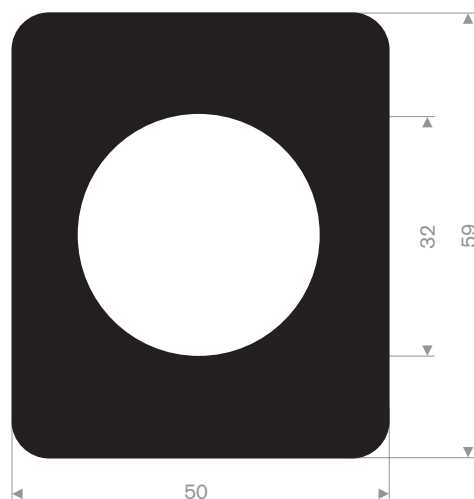

215.06.052  
EPDM 70° Shore sort  
rull lengde 10 meter

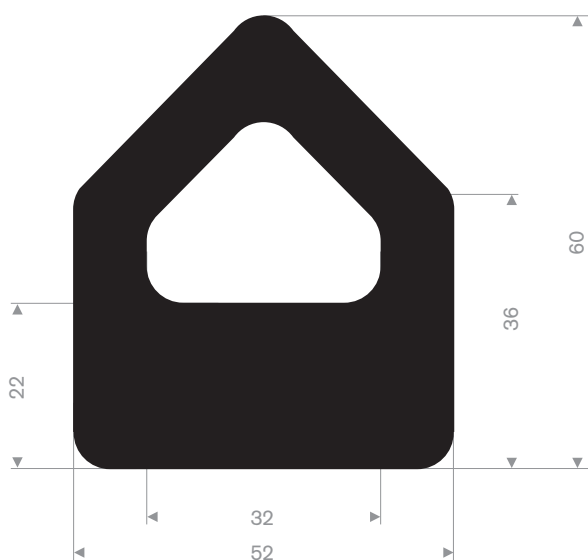

215.65.260  
CR 50° Shore sort  
rull lengde 5 meter

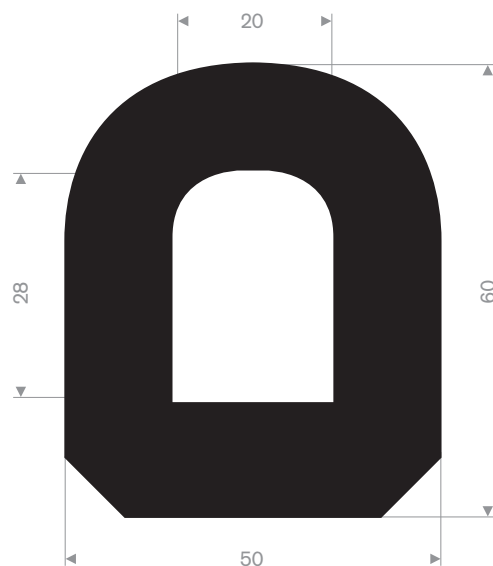

215.15.060  
EPDM 70° Shore sort  
rull lengde 10 meter

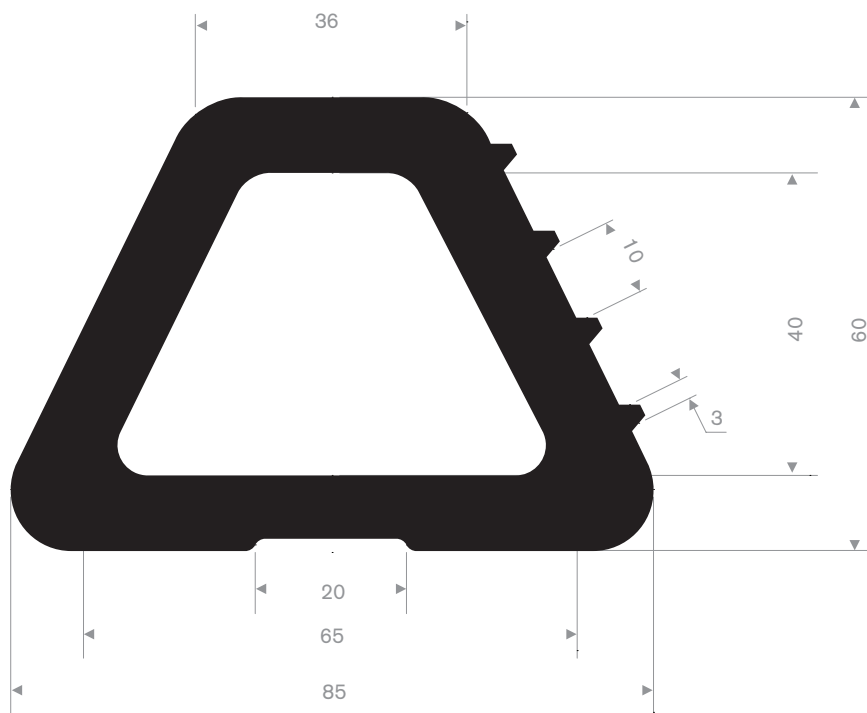

215.08.560  
EPDM 70° Shore sort  
rull lengde 6 meter

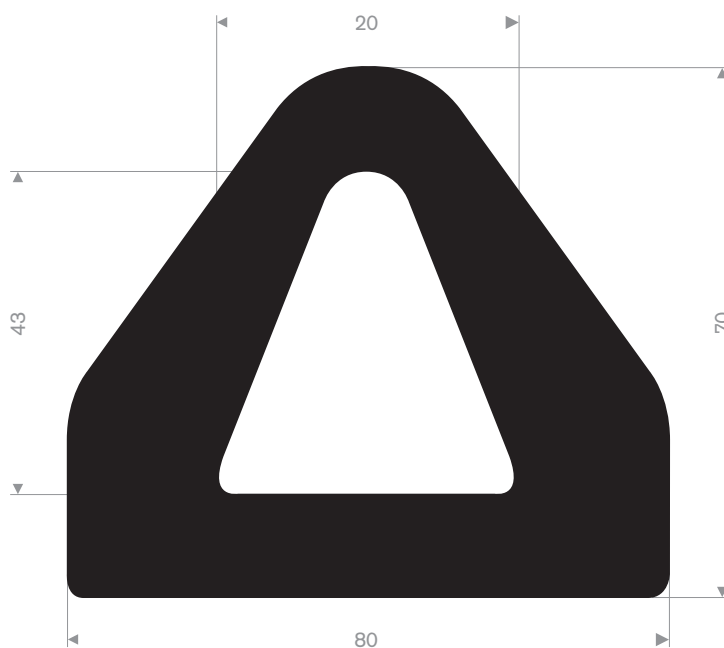

215.28.070  
EPDM 70° Shore sort  
rull lengde 10 meter

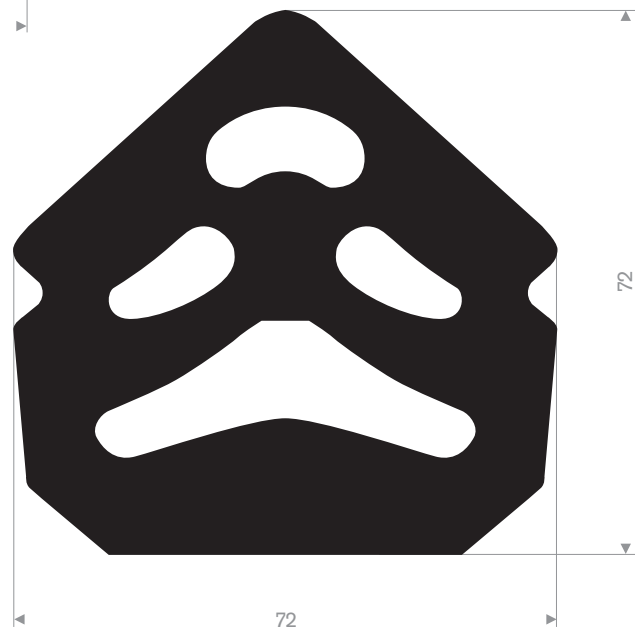
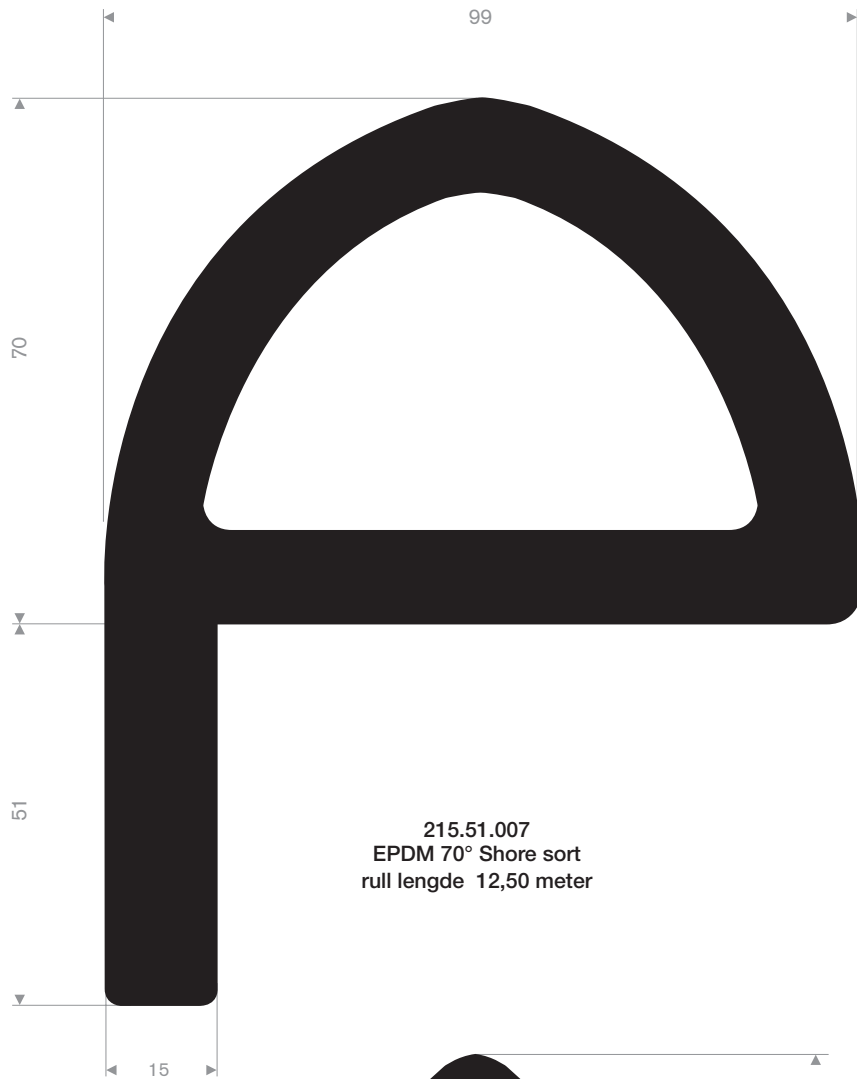

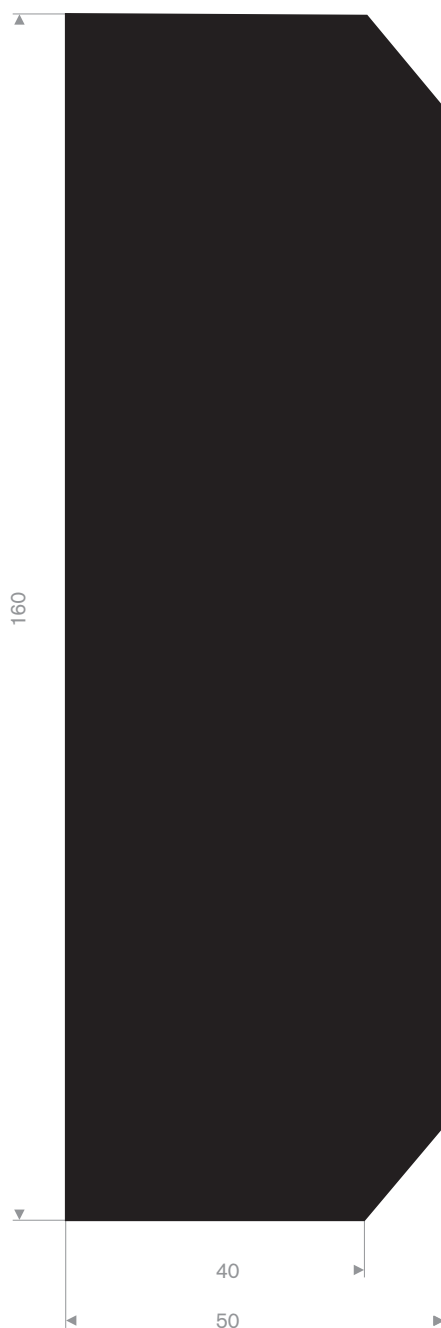

215.01.200  
EPDM 70° Shore sort  
rull lengde 10 meter

### Block-fendere

Dimensjoner		Hull diameter ø d i mm	Maximum lengde inmeter	Tilnærmet vekt i kg/m
bredde B i mm	høyde H i mm			
50	59	32	10	3.5
100	100	50	10	10.5
150	150	76	10	23
200	200	76	6	45
250	250	102	6	68
300	300	130	6	95

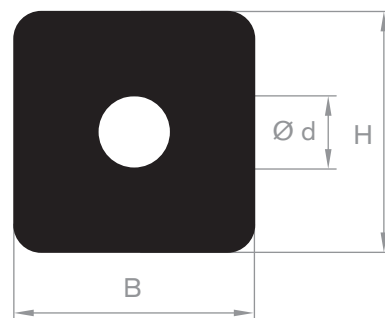

### Nøkkelhull-fendere

Dimensjoner		Lengde in meters	Tilnærmet vekt i kg/m
bredde B i mm	høyde H i mm		
200	200	200	6.2
250	250	250	14

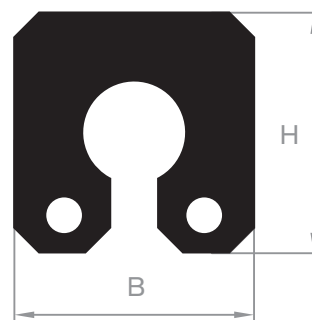

Ovenforstående fendere kan også leveres i henhold til kundespesikke lengder og med hull for montering.

Sylindrisk fendere

Dimensjoner		Maksimum lengde i meter	Tilnærmet vekt i kg/m
OD D	ID d		
100	50	10	7
150	75	10	16
200	100	6	29
250	125	6	43
300	150	6	66
380	190	6	106

